

SWITCH
LOGIQ



TEM

ALLGEGENWÄRTIGES SELBSTBEWUSSTSEIN Gemacht für jeden Raum

Ein Design, das in jedem Raum zu Hause ist. Die universellen Linien der Schalter prägen sowohl moderne Arbeitsumgebungen als auch gemütliche, warme Wohnräume. Für jeden Wunsch bietet Ihnen die Familie der LOGIQ Schalter eine einfache und logische Lösung.

OMNIPRESENT CONFIDENCE made for every room

A shape for every room. The switches have universal lines that leave a mark in both modern work environments as well as in cosy, comfortable living spaces. The LOGIQ family offers a simple and logical solution for your every wish.



HARMONIE DER FARBEN Wählen Sie Ihren Farbton

Die LOGIQ Familie zeichnet sich durch die logische Auswahl bewährter und eleganter Farben aus, die Benutzer bevorzugen. Sie müssen sich nicht der Linie anpassen, sondern die LOGIQ Linie passt sich Ihnen an, weshalb wir immer einen Farbton bieten können, der auf Ihre besonderen Wünsche zugeschnitten ist. Logisch.

HARMONY OF COLOURS Choose your hue

The LOGIQ family prides itself on its logical range of verified and elegant hues known and loved by our clients. Don't compromise, the LOGIQ family has you covered. We can always create the hue of colour in accordance with your special request. Logically.

■ anthrazit /
anthracite

■ titan /
titanium

■ weiß-glänzend /
polar white



UNBEGRENZTE FANTASIE

Erstellen Sie Ihre eigene Kombination

LIMITLESS IMAGINATION

Create your own combination

Die LOGIQ Familie ermöglicht es Ihnen, beliebige Kombinationen zusammen zu stellen. Zum einfachen Kombinieren haben wir eine nützliche Ergänzung für Sie erstellt, die Ihnen das Reißen von horizontalen und vertikalen Linien erleichtert. Das sogenannte 55/55-System ermöglicht es Ihnen, immer dieselben universellen Elemente zu verwenden. Wissen Sie schon, was Sie möchten? Keine Sorge, die LOGIQ Schalter lesen Ihre Gedanken.

The LOGIQ family allows you to create your own combination. To make combining simple, we have created a useful system that supports the sequencing of horizontal and vertical lines. The so-called 55/55 system allows you to use the same universal elements every time. Know what you want? Don't worry, the LOGIQ switches can read your mind.



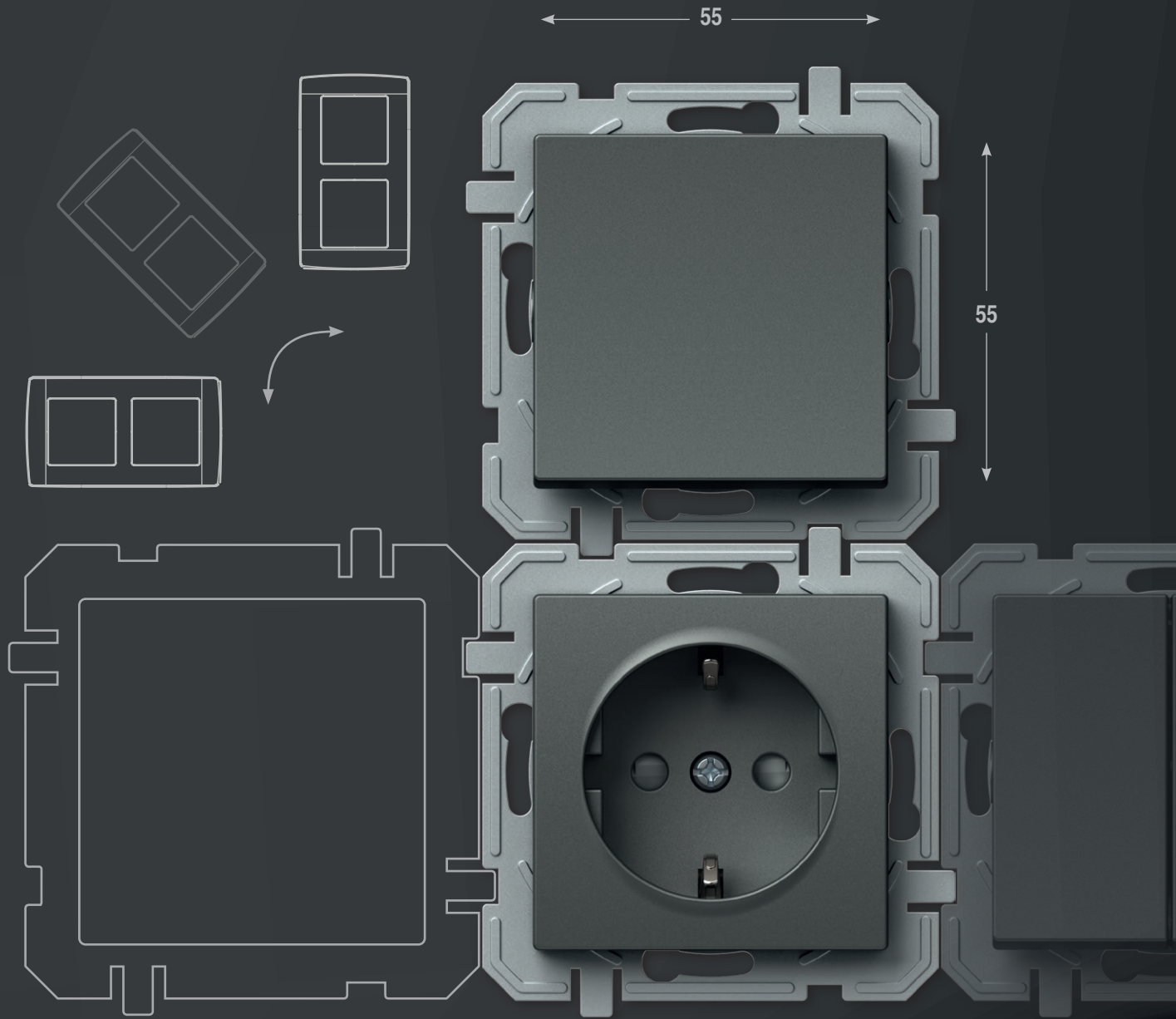

EINFACH FÜR DIE ANSPRUCHSVOLLSTEN

Die LOGIQ Familie sind Schalter, Regler, Sensoren, Steckdosen für jeden Zweck und für jedermann an einem Ort. Sie können einzeln oder im Satz verwendet werden. Wie jede Familie, die wächst und sich entwickelt, werden wir auch unser Angebot entsprechend Ihren Bedürfnissen und Wünschen weiterentwickeln. Wir hören Ihnen gerne zu und bieten Ihnen eine Lösung, die eine einfache und logische Fortsetzung der LOGIQ Familiengeschichte darstellt.

SIMPLE FOR THE MOST DEMANDING

The LOGIQ family offers switches, regulators, sensors, and sockets for every purpose in one place. You can use these products individually or in a sequence. Just like every family that grows and develops, the LOGIQ family will continue to develop our range of products in accordance with your needs and wishes. We are happy to listen to you and offer a solution which will simply and logically continue the story of the LOGIQ family.





ALLES AN EINER STELLE UND MEHR
ALL IN ONE PLACE AND MORE

LOGISCHE MONTAGE LOGICAL INSTALLATION

LOGIQ ist die Lösung für das System der runden Standarddosen. Es ist für einfache wie auch anspruchsvollere Installationen, Neubauten und Umbauarbeiten geeignet. Das System zeichnet sich durch schraublose Kontakte aus, die Ihnen viel Zeit beim Einbau der Elemente ersparen.

LOGIQ is a solution for the system of standardized round installations boxes. It can be used for simple as well as more demanding installations, new buildings and adaptations. The system is characterised by plug-in contacts which save time during installation of elements.

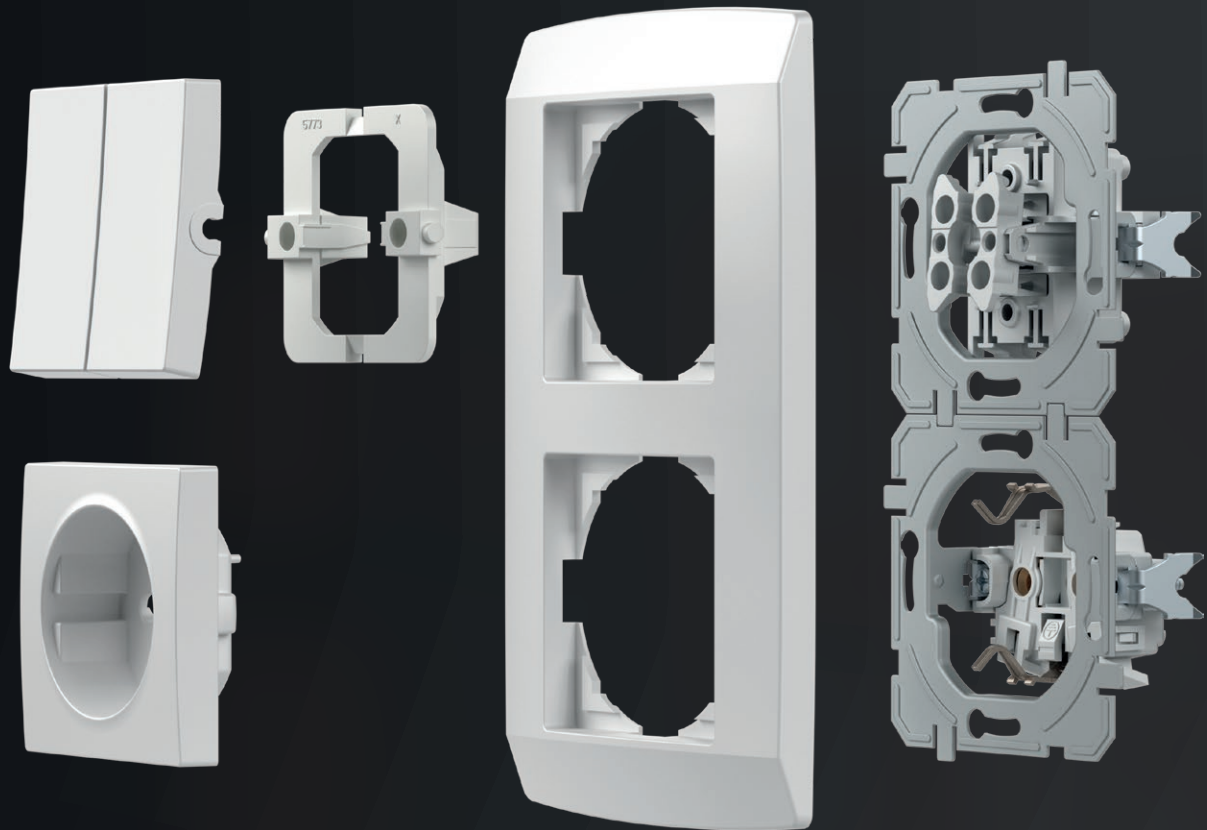

G U T Z U W I S S E N

G O O D T O K N O W



Alle Steckdosen verfügen über einen integrierten Berührungsschutz (Kinderschutz).

All the sockets are equipped with a safety shutters assuring the protection to live contacts.

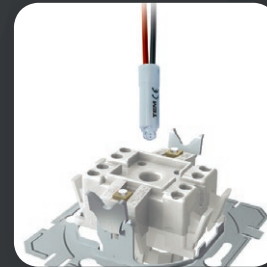

Die gut durchdachte Konstruktion des Schalters ermöglicht auch eine einfache nachträgliche Beleuchtung.

A well-planned switch construction makes easy illumination possible also subsequently.



Für eine zuverlässige Schaltung sorgen Kontakte aus einer Silberlegierung (AgNi).

Contacts made of silver alloy (Ag-Ni) guarantee safe switching.



Die schraublosen Kontakte ermöglichen einen schnellen und zuverlässigen Anschluss der Leitungen. An einem Kontakt können zwei Leitungen mit verschiedenen Durchmessern angeschlossen werden.

Plug-in contacts enable quick and reliable attachment of wires. Two wires of different diameters can be attached to the same contact.



Die Krallen ermöglichen eine tiefere Befestigung (auch an Fliesen usw.).

Fixing claws enable deeper fixing (also through ceramic tiles, etc.)



Erleichtern Sie sich die Arbeit mit schon zusammengesetzten Dosen, die Ihnen die richtigen Abstände gewährleisten.

Easy-fitting installation boxes will make your work easier. Proper lengths are guaranteed.

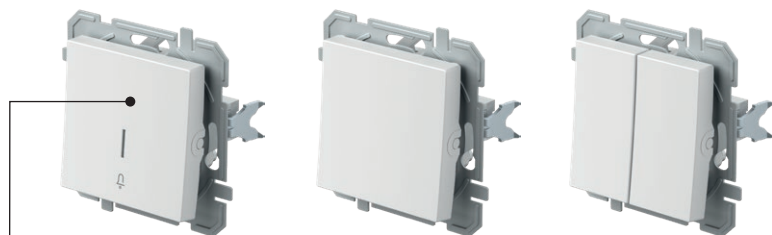





SQ11

PW

IN

01

XO

Typ type	Bezeichnung description	Technische Daten technical data	Farbe colour	Optionsbezeichnung 1 optional data 1	Optionsbezeichnung 2 optional data 2	Optionsbezeichnung 3 optional data 3
SQ10	SCHALTER 1-POLIG SWITCH 1WAY	10AX 250V~	<input type="checkbox"/> PW weiß-glänzend polar white	 NT neutral neutral	 01	XO ohne Rahmen without cover plate
SQ11	TASTER 1-POLIG PUSH BUTTON 1WAY	10A 250V~	<input type="checkbox"/> TI titan titanium	 IN Indikator indicator	 02	
SQ22	SCHALTER 2-POLIG SWITCH 2POLE	16AX 250V~	<input type="checkbox"/> AT anthrazit anthracite		 03	
:	:	:	:	:	:	:

SCHALTER 1-POLIG 10AX 250V~

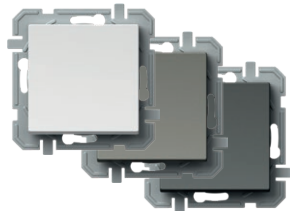

- SQ10PWXO
- SQ10TIXO
- SQ10ATXO



- 10AX 250V~, Typ SQ10
- entspricht EN 60669-1
- Steckklemmen 1,5–2,5 mm²
- SWITCH 1WAY 10AX 250V~
- 10AX 250V~, type SQ10
- in accordance with EN 60669-1
- plug-in contacts 1.5-2.5mm²



SCHALTER 1-POLIG 10AX 250V~ __ IN



- SQ10PWINXO
- SQ10TIINXO
- SQ10ATINXO



- IN Indikator, ohne Glühlampe
- 10AX 250V~, Typ SQ10
- entspricht EN 60669-1
- Steckklemmen 1,5–2,5 mm²
- SWITCH 1WAY 10AX 250V~ __ IN
- IN indicator, without neon lamp
- 10AX 250V~, type SQ10
- in accordance with EN 60669-1
- plug-in contacts 1.5-2.5mm²



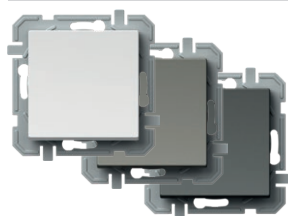

- SQ11PWXO
- SQ11TIXO
- SQ11ATXO

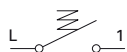

TASTER 1-POLIG 10A 250V~

- 10A 250V~, Typ SQ11
- entspricht EN 60669-1
- Steckklemmen 1,5–2,5 mm²

PUSH BUTTON 1WAY 10A 250V~

- 10A 250V~, type SQ11
- in accordance with EN 60669-1
- plug-in contacts 1.5-2.5mm²



- SQ11PWIN01XO
- SQ11TIIN01XO
- SQ11ATIN01XO

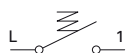

TASTER 1-POLIG 10A 250V~ __ IN 01

- IN 01 Indikator Klingel, ohne Glimmlampe
- 10A 250V~, Typ SQ11
- entspricht EN 60669-1
- Steckklemmen 1,5–2,5 mm²

PUSH BUTTON 1WAY 10A 250V~ __ IN 01

- IN 01 indicator bell, without neon lamp
- 10A 250V~, type SQ11
- in accordance with EN 60669-1
- plug-in contacts 1.5-2.5mm²



- SQ11PWIN02XO
- SQ11TIIN02XO
- SQ11ATIN02XO

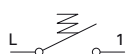

TASTER 1-POLIG 10A 250V~ __ IN 02

- IN 02 Indikator Licht, ohne Glimmlampe
- 10A 250V~, Typ SQ11
- entspricht EN 60669-1
- Steckklemmen 1,5–2,5 mm²

PUSH BUTTON 1WAY 10A 250V~ __ IN 02

- IN 02 indicator light, without neon lamp
- 10A 250V~, type SQ11
- in accordance with EN 60669-1
- plug-in contacts 1.5-2.5mm²

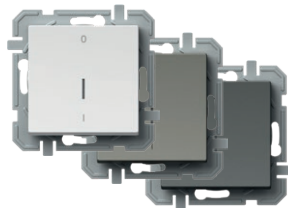

- SQ22PWIN03XO
- SQ22TIIN03XO
- SQ22ATIN03XO

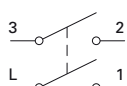

SCHALTER 2-POLIG 16AX 250V~ __ IN 03

- NT 03 neutral 0-1, ohne Glimmlampe
- 16AX 250V~, Typ SQ22
- entspricht EN 60669-1
- Steckklemmen 1,5–2,5 mm²

SWITCH 2POLE 16AX 250V~ __ IN 03

- IN 03 neutral 0-1, without neon lamp
- 16AX 250V~, type SQ22
- in accordance with EN 60669-1
- screw contacts 1.5-2.5mm²

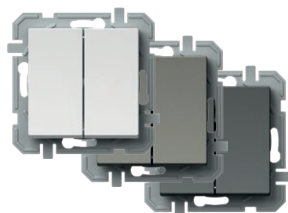

- SQ50PWXO
- SQ50TIXO
- SQ50ATXO

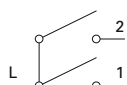

SCHALTER SERIEN 10AX 250V~

- 10AX 250V~, Typ SQ50
- entspricht EN 60669-1
- Steckklemmen 1,5–2,5 mm²

SWITCH 2GANG-1WAY 10AX 250V~

- 10AX 250V~, type SQ50
- in accordance with EN 60669-1
- plug-in contacts 1.5-2.5mm²





- SQ51PWXO
- SQ51TIXO
- SQ51ATXO

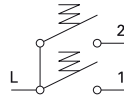

TASTER SERIEN 10A 250V~

- 10A 250V~, Typ SQ51
- entspricht EN 60669-1
- Steckklemmen 1,5–2,5 mm²

PUSH BUTTON 2GANG-1WAY 10A 250V~

- 10A 250V~, type SQ51
- in accordance with EN 60669-1
- plug-in contacts 1.5-2.5mm²



- SQ52PWNT09XO
- SQ52TINT09XO
- SQ52ATNT09XO

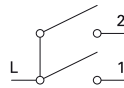

SCHALTER JALOUSIE 10AX 250V~ __ NT 09

- NT 09 neutral aufwärts-abwärts
- 10AX 250V~, Typ SQ52
- entspricht EN 60669-1
- Steckklemmen 1,5–2,5 mm²
- mit mechanischer Verriegelung

SWITCH SHUTTERS 10AX 250V~ __ NT 09

- NT 09 neutral up-down
- 10AX 250V~, type SQ52
- in accordance with EN 60669-1
- plug-in contacts 1.5-2.5mm²
- with mechanical interblock



- SQ53PWNT09XO
- SQ53TINT09XO
- SQ53ATNT09XO

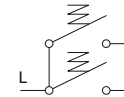

TASTER JALOUSIE 10A 250V~ __ NT 09

- NT 09 neutral aufwärts-abwärts
- 10A 250V~, Typ SQ53
- entspricht EN 60669-1
- Steckklemmen 1,5–2,5 mm²
- mit mechanischer Verriegelung

PUSH BUTTON SHUTTERS 10A 250V~ __ NT 09

- NT 09 neutral up-down
- 10A 250V~, type SQ53
- in accordance with EN 60669-1
- plug-in contacts 1.5-2.5mm²
- with mechanical interblock

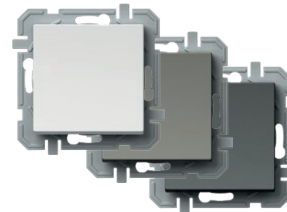
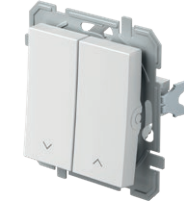

- SQ60PWXO
- SQ60TIXO
- SQ60ATXO

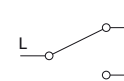

SCHALTER WECHSEL 10AX 250V~

- 10AX 250V~, Typ SQ60
- entspricht EN 60669-1
- Steckklemmen 1,5–2,5 mm²

SWITCH 2WAY 10AX 250V~

- 10AX 250V~, type SQ60
- in accordance with EN 60669-1
- plug-in contacts 1.5-2.5mm²



- SQ63PWXO
- SQ63TIXO
- SQ63ATXO

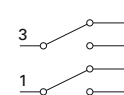

SCHALTER DOPPEL AUS/WECHSEL 10AX 250V~

- 10AX 250V~, Typ SQ63
- entspricht EN 60669-1
- Steckklemmen 1,5–2,5 mm²

SWITCH DOUBLE 2WAY 10AX 250V~

- 10AX 250V~, type SQ63
- in accordance with EN 60669-1
- plug-in contacts 1.5-2.5mm²



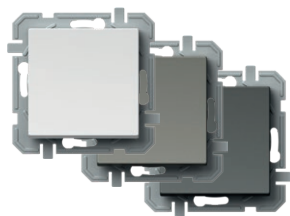

- SQ70PWXO
- SQ70TIXO
- SQ70ATXO



SCHALTER KREUZ 10AX 250V~

- 10AX 250V~, Typ SQ70
- entspricht EN 60669-1
- Steckklemmen 1,5-2,5 mm²

SWITCH INTERMEDIATE 10AX 250V~

- 10AX 250V~, type SQ70
- in accordance with EN 60669-1
- plug-in contacts 1.5-2.5mm²



SQ10
SQ11

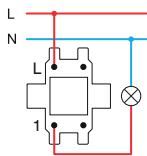

SQ22

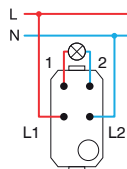

SQ50
SQ51

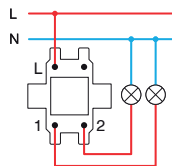

SQ52
SQ53

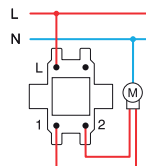

SQ60+SQ60

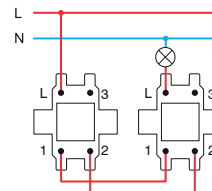

SQ63+SQ63

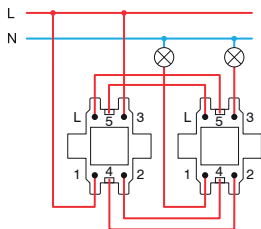

SQ60+SQ70+SQ60

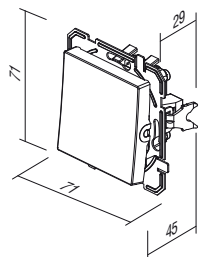
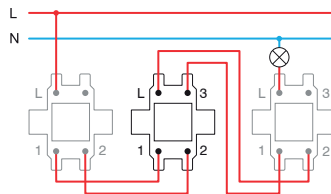

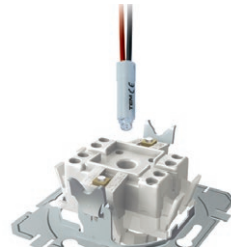
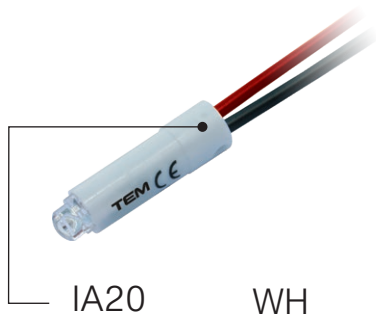

Typ type	Bezeichnung description	Technische Daten technical data	Farbe colour
IA10	GLÜHLAMPE NEON LAMP	230V~ 0,34W	<input type="checkbox"/> WH weiß white
IA20	LED-LAMPE LED LAMP	230V~ 0,40W	<input checked="" type="checkbox"/> BL blau blue
IA21	LED-LAMPE LED LAMP	24V AC/DC 0,20W	<input checked="" type="checkbox"/> RD rot red
.	.	.	<input checked="" type="checkbox"/> GR grün green
.	.	.	<input checked="" type="checkbox"/> OR orange orange



IA10OR

GLÜHLAMPE 230V~ 0,34 W
 - zur Kontrollbeleuchtung, Beleuchtung
 oder ständige Beleuchtung des Schalters
 - in Kombination mit Wippe mit einem Indikator
NEON LAMP 230V~ 0,34W
 - for indication, illumination or
 constant illumination of switch
 - in combination with button with indicator

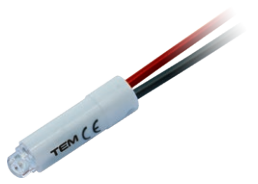

IA20WH
 IA20GR
 IA20RD
 IA20BL

LED-LAMPE 230V AC/DC 0,40 W
 - zur Kontrollbeleuchtung, Beleuchtung
 oder ständige Beleuchtung des Schalters
 - in Kombination mit Wippe mit einem Indikator
LED LAMP 230V AC/DC 0,40W
 - for indication, illumination or
 constant illumination of switch
 - in combination with button with indicator

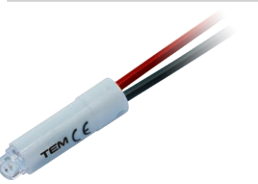

IA21WH
 IA21RD

LED-LAMPE 24V AC/DC 0,20W
 - zur Kontrollbeleuchtung, Beleuchtung
 oder ständige Beleuchtung des Schalters
 - in Kombination mit Wippe mit einem Indikator
LED LAMP 24V AC/DC 0,20W
 - for indication, illumination or
 constant illumination of switch
 - in combination with button with indicator

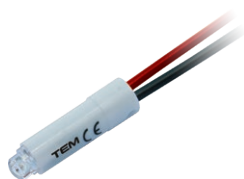

- IA22WH
- IA22RD

LED-LAMPE 12V AC/DC 0,10W

- zur Kontrollbeleuchtung, Beleuchtung oder ständige Beleuchtung des Schalters
- in Kombination mit Wippe mit einem Indikator

LED LAMP 12V AC/DC 0,10W

- for indication, illumination or constant illumination of switch
- in combination with button with indicator

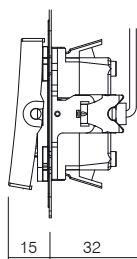

* Kontrollbeleuchtung /
Indication

Beleuchtung /
Illumination

* Ständige Beleuchtung /
Illumination always on

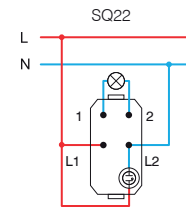
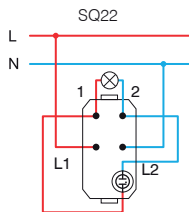
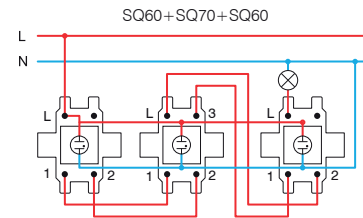
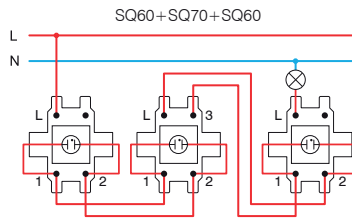
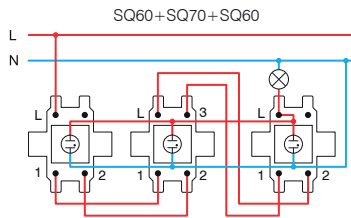
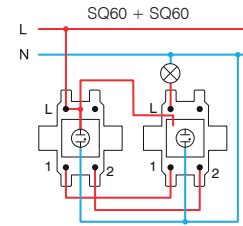
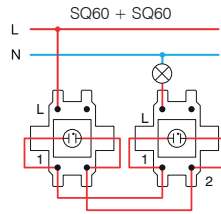
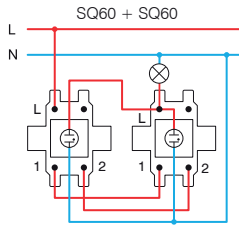
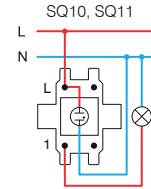
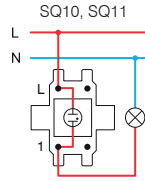
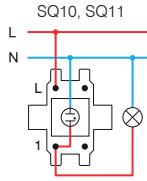

* Schaltung geeignet für Sparlampen (CFL, LED) /
wiring scheme for energy saving lamps (CFL, LED)

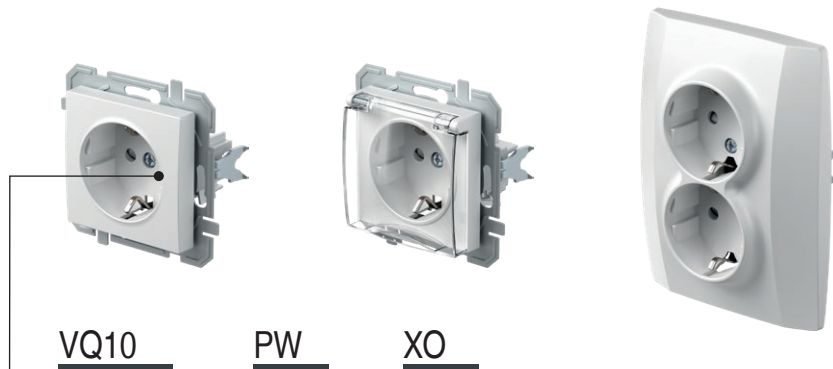

Typ type	Bezeichnung description	Technische Daten technical data	Optionsbezeichnung 1 optional data 1
VQ10	STECKDOSE SCHUKO SOCKET SCHUKO	2P+E 16A 250V~	XO ohne Rahmen without cover plate
VQ11	STECKDOSE SCHUKO+KLAPPDECKEL SOCKET SCHUKO+COVER	2P+E 16A 250V~	
VQ12	STECKDOSE SCHUKO SOCKET SCHUKO	2P+E 16A 250V~ BV	
:	:	:	
:	:	:	

Farbe
colour

<input type="checkbox"/> PW weiß-glänzend polar white	<input type="checkbox"/> PT weiß + transparent white+transparent	<input type="checkbox"/> PP weiß + weiß white+white
<input type="checkbox"/> TI titan titanium	<input type="checkbox"/> TT titan + transparent titanium+transparent	<input type="checkbox"/> TI titan + titan titanium+titanium
<input type="checkbox"/> AT anthrazit anthracite	<input type="checkbox"/> AT anthrazit + transparent anthracite+transparent	<input type="checkbox"/> AA anthrazit + anthrazit anthracite+anthracite
<input type="checkbox"/> RD rot red	<input type="checkbox"/> RT rot + transparent red+transparent	<input type="checkbox"/> RR rot + rot red+red
<input type="checkbox"/> GR grün green	<input type="checkbox"/> GT grün + transparent green+transparent	<input type="checkbox"/> GG grün + grün green+green
<input type="checkbox"/> OR orange orange	<input type="checkbox"/> OT orange + transparent orange+transparent	<input type="checkbox"/> OO orange + orange orange+orange



Schuko – entspricht EN 60884-1, CEE7 (Blatt III)

schuko - in accordance with EN 60884-1, CEE7 (standard sheet III)

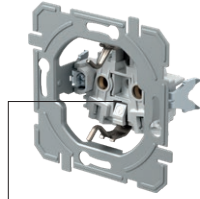

Schraubklemmen
screw contacts

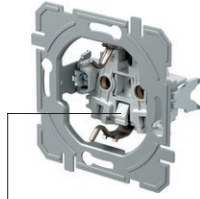

BV Steckklemmen
BV plug-in contacts

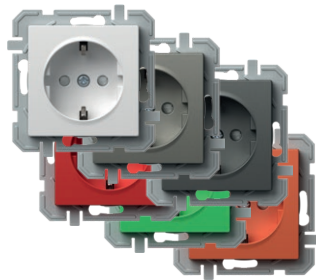

- VQ10PWXO
- VQ10TIXO
- VQ10ATXO
- VQ10RDXO
- VQ10GRXO
- VQ10ORXO

STECKDOSE SCHUKO 2P+E 16A 250V~ __ XO

- Schraubklemmen 1,5–2,5 mm²
- XO ohne Rahmen
- Steckdose mit Schutzkontakt
- 16A 250V~, Typ VQ10
- KS - mit Kinderschutz

SOCKET SCHUKO 2P+E 16A 250V~ __ XO

- screw contacts 1.5-2.5mm²
- XO without surround
- 2P+E schuko
- 16A 250V~, type VQ10
- KS build-in child protection – shuttered live contacts

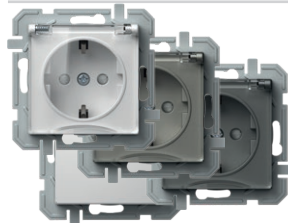

- VQ11PTXO
- VQ11TTXO
- VQ11ATXO
- VQ11PPXO

STECKDOSE SCHUKO+DECKEL 2P+E 16A 250V~ __ XO

- Schraubklemmen 1,5–2,5 mm²
- XO ohne Rahmen
- Steckdose mit Schutzkontakt mit Klappdeckel
- 16A 250V~, Typ VQ11
- KS - mit Kinderschutz

SOCKET SCHUKO+COVER 2P+E 16A 250V~ __ XO

- screw contacts 1.5-2.5mm²
- XO without surround
- 2P+E schuko+cover
- 16A 250V~, type VQ11
- KS build-in child protection – shuttered live contacts

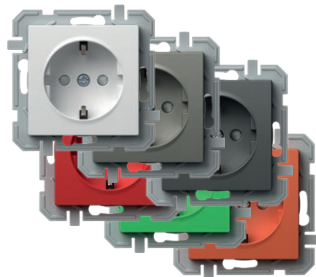

- VQ12PWXO
- VQ12TIXO
- VQ12ATXO
- VQ12RDXO
- VQ12GRXO
- VQ12ORXO

STECKDOSE SCHUKO 2P+E 16A 250V~ BV_XO

- BV – Steckklemmen 1,5–2,5 mm²
- XO ohne Rahmen
- Steckdose mit Schutzkontakt
- 16A 250V~, Typ VQ12
- KS - mit Kinderschutz

SOCKET SCHUKO 2P+E 16A 250V~ BV __ XO

- BV plug-in contacts 1.5-2.5mm²
- XO without surround
- 2P+E schuko
- 16A 250V~, type VQ12
- KS build-in child protection – shuttered live contacts



STECKDOSE SCHUKO+KLAPPDECKEL 2P+E 16A 250V~ BV __ XO

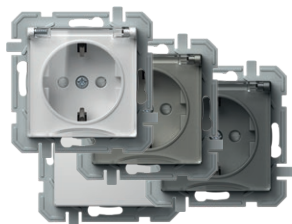

- VQ13PTXO
- VQ13TTXO
- VQ13ATXO
- VQ13PPXO

- BV – Steckklemmen 1,5–2,5 mm²
- XO ohne Rahmen
- Steckdose mit Schutzkontakt mit Klappdeckel
- 16A 250V~, Typ VQ13
- KS - mit Kinderschutz



SOCKET SCHUKO+COVER 2P+E 16A 250V~ BV __ XO

- BV plug-in contacts 1.5-2.5mm²
- XO without surround
- 2P+E schuko+cover
- 16A 250V~, type VQ13
- KS build-in child protection – shuttered live contacts

STECKDOSE SCHUKO DOPPELT 2P+E 16A 250V~



- VQ16PW
- VQ16TI
- VQ16AT

- Doppelsteckdose mit Schutzkontakt
- 16A 250V~, Typ VQ16
- entspricht IEC 60884-1, CEE7
- Schraubklemmen 1,5-2.5 mm²
- KS - mit Kinderschutz

SOCKET SCHUKO DOUBLE 2P+E 16A 250V~

- 2P+E schuko double
- 16A 250V~, type VQ16
- in accordance with IEC 60884-1, CEE7
- screw contacts 1.5-2.5 mm²
- KS build-in child protection – shuttered live contacts

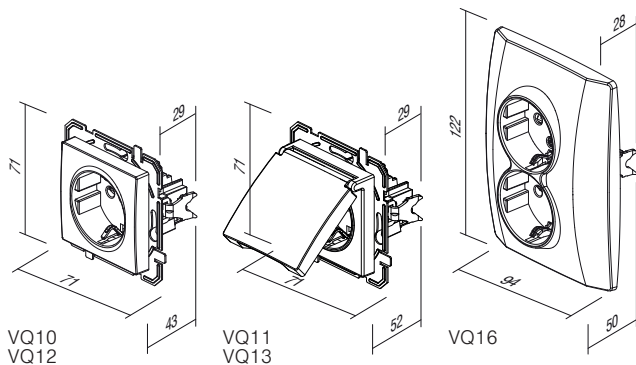



KQ37

PW

XO

Typ type	Bezeichnung description	Technische Daten technical data	Farbe colour	Optionsbezeichnung 1 optional data 1
KQ11	STECKDOSE TV-R ENDDOSE SOCKET TV-R END-LINE	1dB	<input type="checkbox"/> PW weiß-glänzend polar white	XO ohne Rahmen without cover plate
KQ12	STECKDOSE TV-R DURCHGANGSDOSE SOCKET TV-R THROUGHPASS	10dB	<input type="checkbox"/> TI titan titanium	
KQ16	STECKDOSE SAT-TV-R ENDDOSE SOCKET SAT-TV-R END-LINE	3dB	<input type="checkbox"/> AT anthrazit anthracite	
⋮	⋮	⋮		

STECKDOSE TV-EINZELDOSE 0dB



- KQ10PWXO
- KQ10TIXO
- KQ10ATXO

- TV-Einzeldose
- Dämpfung 0 dB
- Rückanschluss – F-Standard

SOCKET TV BASIC 0dB

- TV basic
- reduction 0dB
- back connector – F standard



STECKDOSE TV-R-ENDDOSE 1dB



- KQ11PWXO
- KQ11TIXO
- KQ11ATXO

- TV-R-Enddose
- Übertragungsbandbreite 5-862 MHz
- Dämpfung: R-1.5dB, TV-1dB
- entspricht EN 50083-1
- Schraubklemmen

SOCKET TV-R END-LINE 1dB

- TV-R end-line
- frequency range 5-862 MHz
- reduction: R-1.5dB, TV-1dB
- in accordance with EN 50083-1
- screw contact





- KQ12PWXO
- KQ12TIXO
- KQ12ATXO

STECKDOSE TV-R DURCHGANGSDOSE 10dB

- TV-R-Durchgangsdose
- Übertragungsbandbreite 5-862 MHz
- Dämpfung: R-10dB, TV-10dB, Durchgang-2dB
- entspricht EN 50083-1
- Schraubklemmen

SOCKET TV-R TROUGH-PASS 10dB

- TV-R troughpass
- frequency range 5÷862 MHz
- reduction: R-10dB, TV-10dB, trough-2dB
- in accordance with EN 50083-1
- screw contacts



- KQ16PWXO
- KQ16TIXO
- KQ16ATXO

STECKDOSE SAT-TV-R-ENDDOSE 3dB

- SAT-TV-R-Enddose
- Übertragungsbandbreite 5-2400 MHz
- Dämpfung: R-1 dB, TV-1,5 dB, SAT-3 dB
- entspricht EN 50083-1
- Schraubklemmen

SOCKET SAT-TV-R END-LINE 3dB

- SAT-TV-R end-line
- frequency range 5÷2400 MHz
- reduction: R-1dB, TV-1.5dB, SAT-3dB
- in accordance with EN 50083-1
- screw contacts

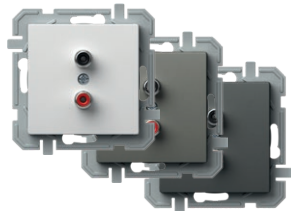

- KQ22PWXO
- KQ22TIXO
- KQ22ATXO

STECKDOSE AUDIO 2xRCA

- Audio 2xRCA
- gelöteter Kabelanschluss

SOCKET AUDIO 2xRCA

- audio 2xRCA
- soldering connection of cable



- KQ23PWXO
- KQ23TIXO
- KQ23ATXO

STECKDOSE AUDIO FÜR LAUTSPRECHER

- Audio-Anschlussdose – 2x Ø4 mm
- Kabelanschluss für Lautsprecher, Stecker Ø4 mm oder Gabel-Kabelstecker
- gelöteter Kabelanschluss hinten

SOCKET AUDIO LOUDSPEAKERS

- audio 2x Ø4mm
- to accommodate speaker wire, banana plug Ø4mm or spades
- soldering connection of cable at the back side

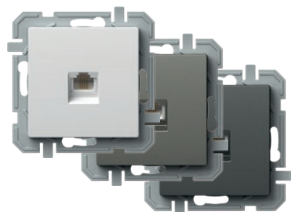

- KQ36PWXO
- KQ36TIXO
- KQ36ATXO

STECKDOSE TEL KS RJ11 6/4

- KS – keystone-Befestigungsstandard
- RJ11 6/4
- entspricht IEC 60603-7

SOCKET TEL KS RJ11 6/4

- KS keystone fixing standard
- RJ11 6/4
- in accordance with IEC 60603-7



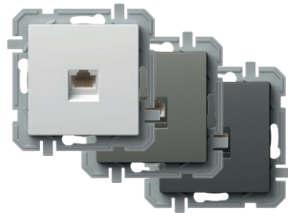

- KQ37PWXO
- KQ37TIXO
- KQ37ATXO

STECKDOSE CAT5e KS RJ45 8/8

- KS – keystone-Befestigungsstandard
- CAT5e, RJ45 8/8
- entspricht IEC 60603-7

SOCKET CAT5e KS RJ45 8/8

- KS keystone fixing standard
- CAT5e, RJ45 8/8
- in accordance with IEC 60603-7

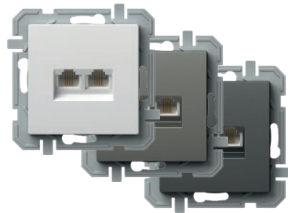

- KQ38PWXO
- KQ38TIXO
- KQ38ATXO

STECKDOSE TEL KS DOPPELT 2x RJ11 6/4

- KS – keystone-Befestigungsstandard
- 2x RJ11 6/4
- entspricht IEC 60603-7

SOCKET TEL KS DOUBLE 2x RJ11 6/4

- KS keystone fixing standard
- 2x RJ11, 6/4
- in accordance with IEC 60603-7

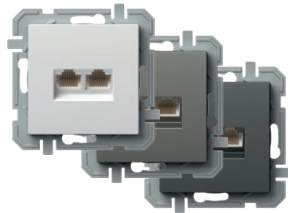

- KQ39PWXO
- KQ39TIXO
- KQ39ATXO

STECKDOSE CAT5e KS DOPPELT 2x RJ45 8/8

- KS – keystone-Befestigungsstandard
- 2x CAT5e, RJ45 8/8
- entspricht IEC 60603-7

SOCKET CAT5e KS DOUBLE 2x RJ45 8/8

- KS keystone fixing standard
- 2x CAT5e, RJ45 8/8
- in accordance with IEC 60603-7

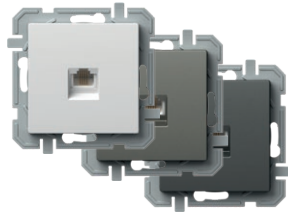

- KQ35PWXO
- KQ35TIXO
- KQ35ATXO

STECKDOSE TEL LT RJ11 6/4

- TEL LT mit Schraubklemmen
- Schraubklemmen
- RJ11 6/4
- entspricht IEC 60603-7

SOCKET TEL LT RJ11 6/4

- TEL LT screw
- screw contacts
- RJ11 6/4
- in accordance with IEC 60603-7

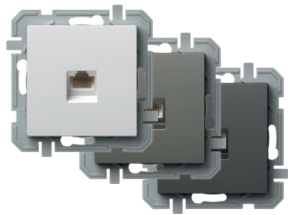

- KQ40PWXO
- KQ40TIXO
- KQ40ATXO

STECKDOSE CAT6 KS RJ45 8/8

- KS – keystone-Befestigungsstandard
- CAT6, RJ45 8/8
- entspricht IEC 60603-7

SOCKET CAT6 KS RJ45 8/8

- KS keystone fixing standard
- CAT6, RJ45 8/8
- in accordance with IEC 60603-7



STECKDOSE 2xCAT6 KS RJ45 8/8

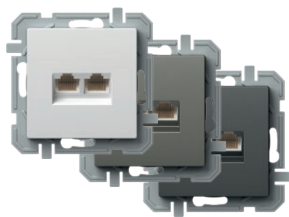

- KQ41PWXO
- KQ41TIXO
- KQ41ATXO

- KS – keystone-Befestigungsstandard
 - 2xCAT6, RJ45 8/8
 - entspricht IEC 60603-7

SOCKET 2xCAT6 KS RJ45 8/8

- KS keystone fixing standard
 - 2xCAT6, RJ45 8/8
 - in accordance with IEC 60603-7

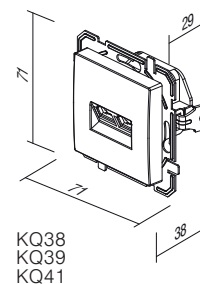
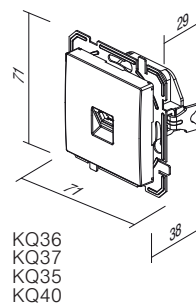
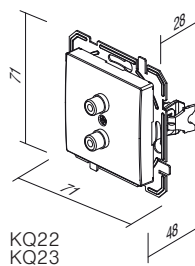
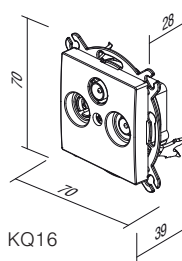
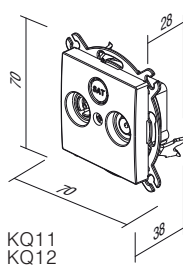
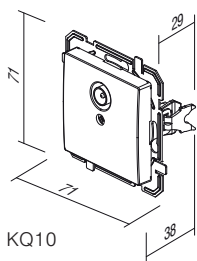

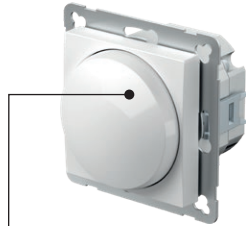

EQ15

PW

XO

Typ type	Bezeichnung description	Technische Daten technical data	Farbe colour	Optionsbezeichnung 1 optional data 1
EQ15	DIMMER DREH-WECHSEL DIMMER ROTATIVE 2WAY	RL 400W	<input type="checkbox"/> PW weiß-glänzend polar white	XO ohne Rahmen without cover plate
EQ16	DIMMER DREH-WECHSEL DIMMER ROTATIVE 2WAY	RLC 400W	<input type="checkbox"/> TI titan titanium	
EQ19	DIMMER DREH-WECHSEL DIMMER ROTATIVE 2WAY	LED 100W	<input type="checkbox"/> AT anthrazit anthracite	
⋮	⋮	⋮		

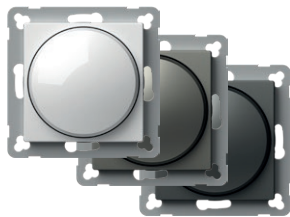

- EQ15PWXO
- EQ15TIXO
- EQ15ATXO

DIMMER DREH-WECHSEL RL 400W

- Dreh-Wechsel
- Belastung RL, 40W – 400W
- kann mit Wechselschalter verbunden werden
- Verbindung von zwei Dimmern ist nicht gestattet
- entspricht EN 60669-1 und EN 60669-2-1
- Schraubklemmen 1,5 mm²
- Versorgung 230 V[~] 50 Hz
- inkl. Sicherung auswechselbar

DIMMER ROTATIVE 2WAY RL 400W

- rotation control with 2-way switch
- load RL, 40W - 400W
- 2-way switch combination is possible
- more dimmers combination is not allowed
- in accordance with EN 60669-1 and EN 60669-2-1
- plug-in contacts 1.5mm²
- supply 230V[~] 50Hz
- replaceable fuse included



DIMMER DREH-WECHSEL RLC 400W

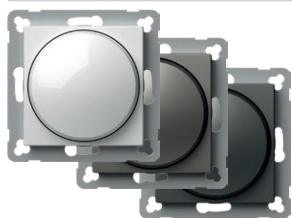

- EQ16PWXO
- EQ16TIXO
- EQ16ATXO

- Dreh-Wechsel
- Belastung RL, 20–400 W
- kann mit Wechselschalter verbunden werden
- Verbindung von zwei Dimmern ist nicht gestattet
- entspricht EN 60669-1 und EN 60669-2-1
- Steckklemmen 1,5 mm²
- Versorgung 230 V~ 50 Hz
- Elektronsicherung

*DIMMER ROTATIVE 2WAY RLC 400W*

- rotation control with 2-way switch
- load RLC, 20W - 400W
- 2-way switch combination is possible
- more dimmers combination is not allowed
- in accordance with EN 60669-1 and EN 60669-2-1
- plug-in contacts 1.5mm²
- supply 230V~ 50Hz
- electronic fuse

DIMMER DREH-WECHSEL LED 100W

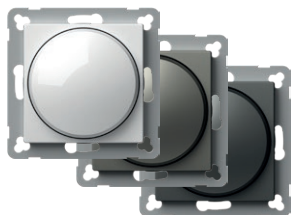

- EQ19PWXO
- EQ19TIXO
- EQ19ATXO

- Dreh-Wechsel
- Belastung: LED, 0-100 W (max. 10 LED-Lampen)
- GLS, 10-250 W
- kann mit Wechselschalter verbunden werden
- Verbindung von zwei Dimmern ist nicht gestattet
- entspricht EN 60669-1 und EN 60669-2-1
- Schraubklemmen 1,5 mm²
- Versorgung 230 V~ 50 Hz
- inkl. Sicherung auswechselbar

*DIMMER ROTATIVE 2WAY LED 100W*

- rotation control with 2-way switch
- load: LED, 0-100W (max. 10 LEDs)
- GLS, 10-250W
- 2-way switch combination is possible
- more dimmers combination is not allowed
- in accordance with EN 60669-1 and EN 60669-2-1
- plug-in contacts 1.5mm²
- supply 230V~ 50Hz
- replaceable fuse included

EQ15, EQ16, EQ19

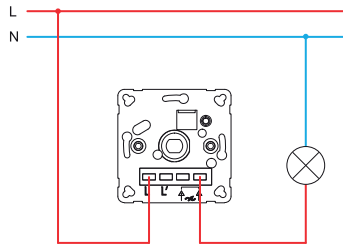

EQ15, EQ16, EQ19

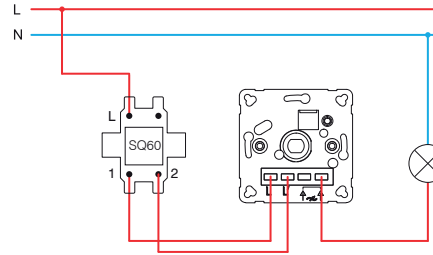

EQ15, EQ16, EQ19

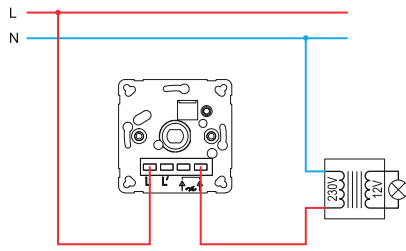

EQ15, EQ16, EQ19

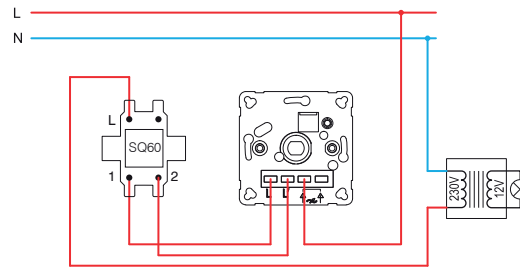

EQ16, EQ19

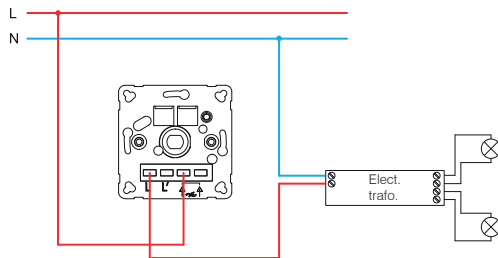

EQ16, EQ19

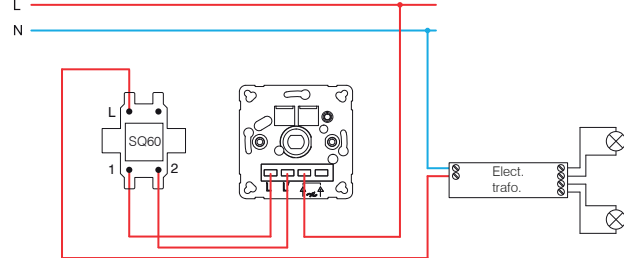

EQ15 (40÷400W)

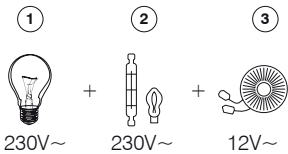

- 1 – Glühlampe /
incandescent lamp
 2 – Halogenlampe /
halogen lamp

EQ16 (20÷400W)

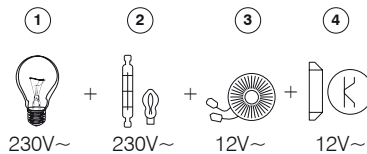

- 3 – klassischer Transformator /
classical transformer
 4 – elektronischer Transformator /
electronic transformer

EQ19 (GLS 10÷250W ; LED 0÷100W)

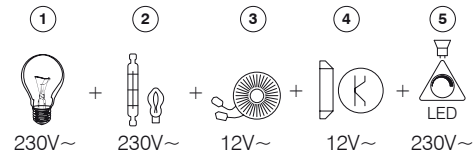

- 5 – dimmbare LED-Lampe /
dimmbable LED lamp

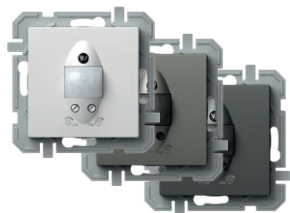

- EQ32PWXO
- EQ32TIXO
- EQ32ATXO

IR SCHALTER 5A 230V~

- IR-Schalter
- Versorgung: 230V~ $\pm 10\%$ 50Hz
- Relais: 5A / 250V~ Ausgang mit hochohmigen Strombegrenzung für den Nulldurchgang
- Schutzart: IP40
- Schraubklemmen: 0,75–2,5 mm²
- Erfassungswinkel: bis 110° bei 20°C
- Erfassungsbereich: ca. 8 m bei 20°C
- Einstellung der Beleuchtungszeit: ab ca. 5 s bis 12 min
- Beleuchtungseinstellung: von ca. 5 bis 200 Lx
- Betriebstemperatur: von 0°C bis +40°C
- nicht geeignet für den Einbau in Dosen mit Tiefe 45 mm
- nur für Gebrauch im Innenbereich

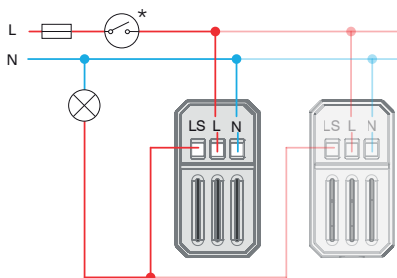

IR SWITCH 5A 230V~

- IR infrared switch
- supply voltage: 230V~ $\pm 10\%$ 50Hz
- relay: 5A / 250V~ output for limited current with high resistance for zero crossing
- protection rating: IP40
- cross-section of wires at the contact terminal: 0.75 - 2.5 mm²
- detection angle: up to 110° at 20°C
- detection area: approx. 8 m at 20°C
- adjustability of duration: from approx. 5 s to 12 min
- adjustability of brightness: from approx. 5 to 200 LUX
- operating temperature: from 0°C to +40°C
- not suitable for installation in 45 mm deep boxes
- only for indoor usage

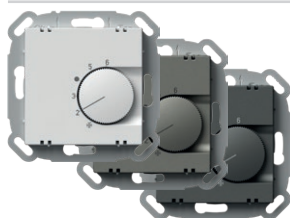

- EQ35PWXO
- EQ35TIXO
- EQ35ATXO

THERMOSTAT HEIZUNG

- Betriebsart: Heizung
- Versorgung: 230 VAC, 50 Hz
- Ausgang: 4 A (max. 10 A), 230 VAC, 50 Hz
- Ausgang: NC (max. 10 Aktoren)
- Regulierungsbereich: +5 °C bis +30 °C
- Hysterese: 0,5 K
- Schutzart: IP30
- Sensorart: bimetal
- elektrischer Anschluss: Steckklemmen
- Leitung Typ: 0,75–1,5 mm² (Weichdraht) oder 1,0–2,5 mm² (Hartdraht)

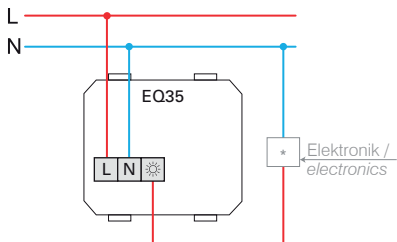

THERMOSTAT HEATING

- operation mode: heating
- power supply: 230 VAC, 50 Hz
- output: 4 A (max. 10 A), 230 VAC, 50 Hz
- switching contact: NC (max. 10 actuators)
- regulation range: +5 °C to +30 °C
- hysteresis: 0,5 K
- protection: IP30
- sensor type: bimetal
- type of electrical connection: spring-loaded contacts
- type of conductors: 0,75 – 1,5mm² (flexible-stranded core) or 1,0 – 2,5 mm² (solid core)

THERMOSTAT HEIZUNG / KÜHLUNG

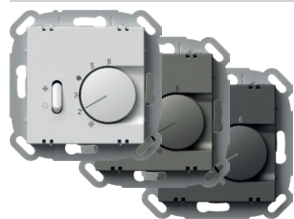

- EQ36PWXO
- EQ36TIXO
- EQ36ATXO

- Betriebsart: Heizung / Kühlung
- Versorgung: 230 VAC, 50 Hz
- Ausgang: 2 A (max. 5 A), 230 VAC, 50 Hz
- Ausgang: Umschalter (max. 5 Aktoren)
- Regulierungsbereich: +5 °C bis +30 °C
- Hysterese: 0,5 K
- Schutzart: IP30
- Sensorart: bimetal
- elektrischer Anschluss: Steckklemmen
- Leitung Typ:
0,75–1,5 mm² (Weichdraht) oder
1,0–2,5 mm² (Hartdraht)

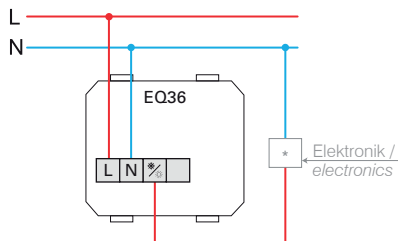

THERMOSTAT HEATING / COOLING

- operation mode: heating / cooling
- power supply: 230 VAC, 50 Hz
- output: 2 A (max. 5 A), 230 VAC, 50 Hz
- switching contact: changeover switch (toggler, max. 5 actuators)
- regulation range: +5 °C to +30 °C
- hysteresis: 0,5 K
- protection: IP30
- sensor type: bimetal
- type of electrical connection: spring-loaded contacts
- type of conductors:
0,75 – 1,5mm² (flexible-stranded core) or
1,0 – 2,5 mm² (solid core)

THERMOSTAT BODENHEIZUNG

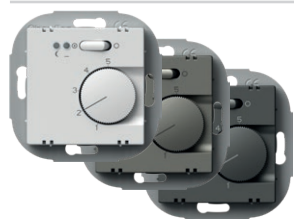

- EQ37PWXO
- EQ37TIXO
- EQ37ATXO

- Betriebsart: Bodenheizung
- Versorgung: 230 VAC, 50 Hz
- Ausgang: 2 A (max. 16 A), 230 VAC, 50 Hz
- Regulierungsbereich: +10 °C bis +50 °C
- Hysterese: 1 K
- Schutzart: IP30
- Sensorart: NTC nach DIN EN 60730-2-1
- Indikator:
rote LED für Heizung ein
grüne LED für reduzierten Nacht-Modus
- elektrischer Anschluss: Schraubklemmen
- Leitung Typ: 0,5–2,5 mm²

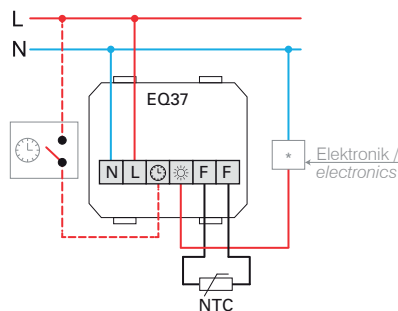

THERMOSTAT FLOOR HEATING

- operation mode: floor heating
- power supply: 230 VAC, 50 Hz
- output: 2 A (max. 16 A), 230 VAC, 50 Hz
- regulation range: +10 °C to +50 °C
- hysteresis: 1 K
- protection: IP30
- sensor type: NTC in compliance with DIN EN 60730-2-1
- indicators: Red LED for heating and green LED for night decrease mode
- type of electrical connection: Screw contacts
- type of conductors: 0,5 – 2,5mm²

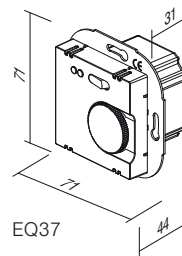
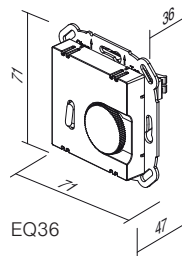
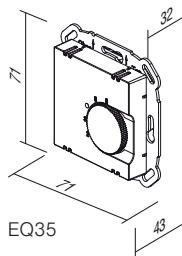
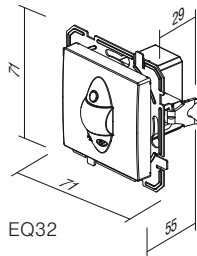
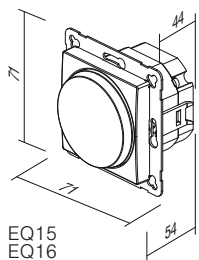

EQ15
EQ16
EQ19

EQ32

EQ35

EQ36

EQ37

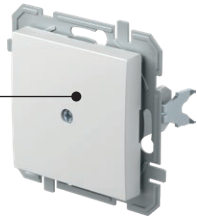

PQ10

PW

XO

Typ type	Bezeichnung description	Farbe colour	Optionsbezeichnung 1 optional data 1
PQ10	BLENDE BLANK	<input type="checkbox"/> PW weiß-glänzend polar white	XO ohne Rahmen without cover plate
PQ30	DECKEL TAE/TDO COVER TAE/TDO	<input type="checkbox"/> TI titan titanium <input type="checkbox"/> AT anthrazit anthracite	

BLENDE



- PQ10PWXO
- PQ10TIXO
- PQ10ATXO

- zum Abdecken von leeren Öffnungen

BLANK

- for filling up empty spaces



DECKEL TAE/TDO

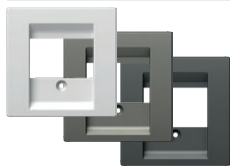

- PQ30PW
- PQ30TI
- PQ30AT

- TAE- oder TDO-Deckel mit Schraube

COVER TAE/TDO

- TAE or TDO cover with screw

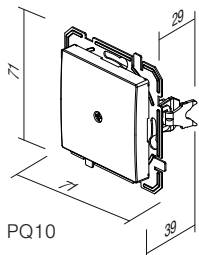

PQ10

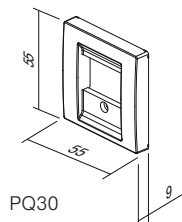

PQ30



OQ10

PW

Typ type	Bezeichnung description	Farbe colour
OQ10	RAHMEN LOGIQ 1 COVER PLATE LOGIQ 1	PW weiß-glänzend polar white
OQ20	RAHMEN LOGIQ 2 COVER PLATE LOGIQ 2	TI titan titanium
OQ30	RAHMEN LOGIQ 3 COVER PLATE LOGIQ 3	AT anthrazit anthracite
:	:	
:	:	



- OQ10PW
- OQ10TI
- OQ10AT

RAHMEN LOGIQ 1

- dekorativer Rahmen 1-fach
- entspricht EN 60669-1

COVER PLATE LOGIQ 1

- decorative cover plate 1-gang
- in accordance with EN 60669-1

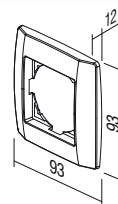

- OQ20PW
- OQ20TI
- OQ20AT

RAHMEN LOGIQ 2

- dekorativer Rahmen 2-fach
- entspricht EN 60669-1

COVER PLATE LOGIQ 2

- decorative cover plate 2-gang
- in accordance with EN 60669-1

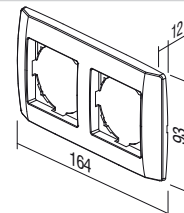



- QQ30PW
- QQ30TI
- QQ30AT

RAHMEN LOGIQ 3

- dekorativer Rahmen 3-fach
- entspricht EN 60669-1

COVER PLATE LOGIQ 3

- decorative cover plate 3-gang
- in accordance with EN 60669-1

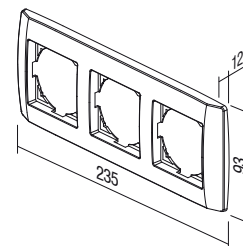

- QQ40PW
- QQ40TI
- QQ40AT

RAHMEN LOGIQ 4

- dekorativer Rahmen 4-fach
- entspricht EN 60669-1

COVER PLATE LOGIQ 4

- decorative cover plate 4-gang
- in accordance with EN 60669-1

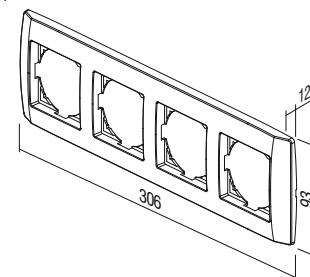

- QQ50PW
- QQ50TI
- QQ50AT

RAHMEN LOGIQ 5

- dekorative Rahmen 5-fach
- entspricht EN 60669-1

COVER PLATE LOGIQ 5

- decorative cover plate 5-gang
- in accordance with EN 60669-1

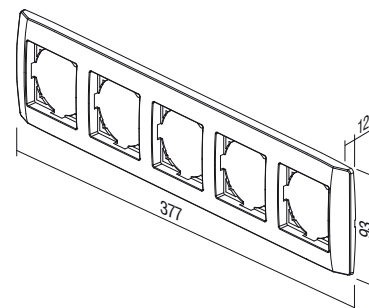

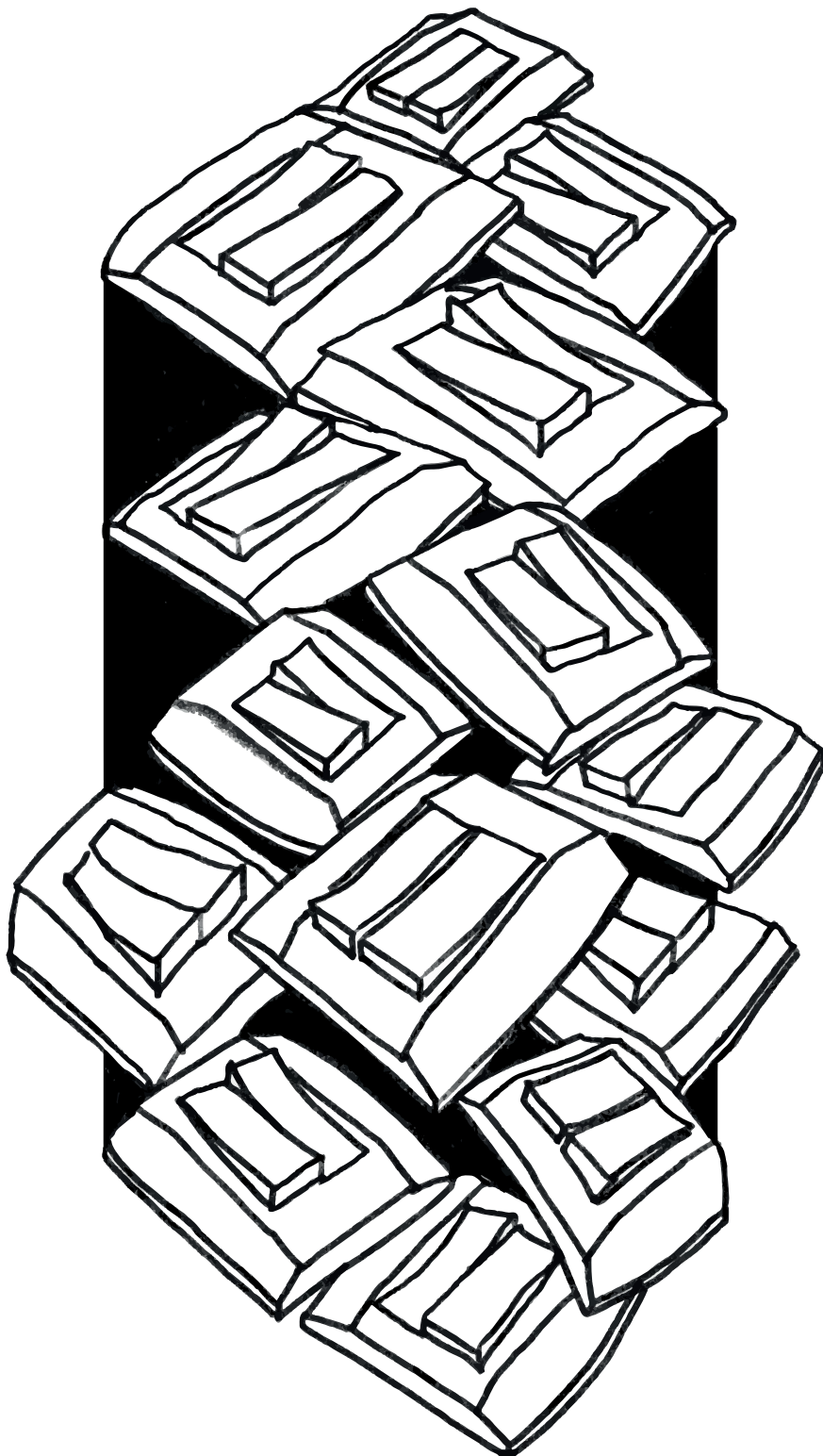

TEM

TEM Čatež d.o.o.
Čatež 13, 8212 Velika Loka
Slovenija
e: info@tem.si
w: www.tem.si
t: +386 (0)7 348 99 00

WJ1220DE-T (18431)
Katalog 2020, 1. Ausgabe, 04/2020

TEM
WWW.TEM.SI
DE 2020